

facilitating the informality

formal infrastructure for an informal market

ariadne gutierrez flores | cedim
celso rojas | texas a&m university
barcelona architecture center spring 2014

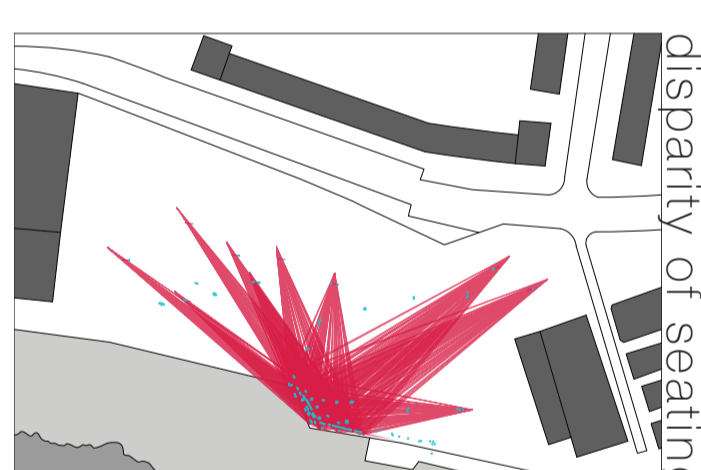
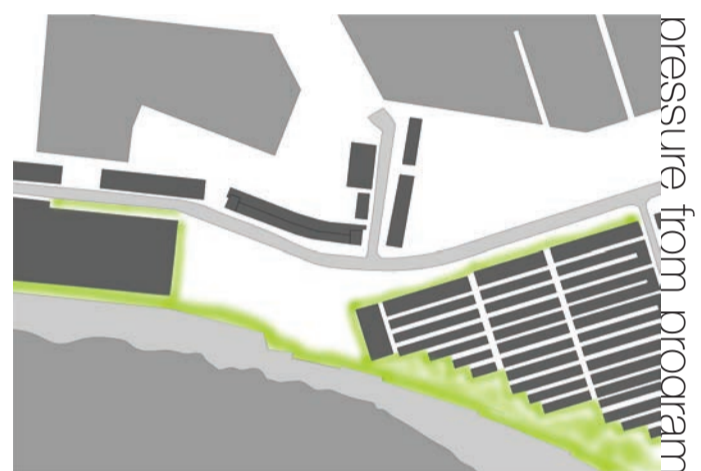
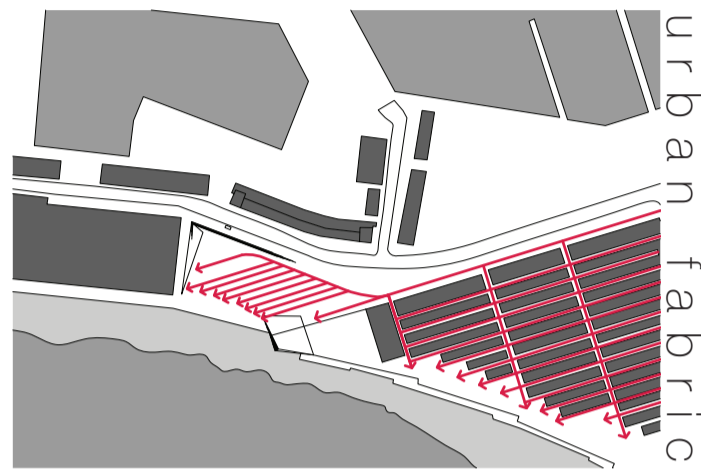
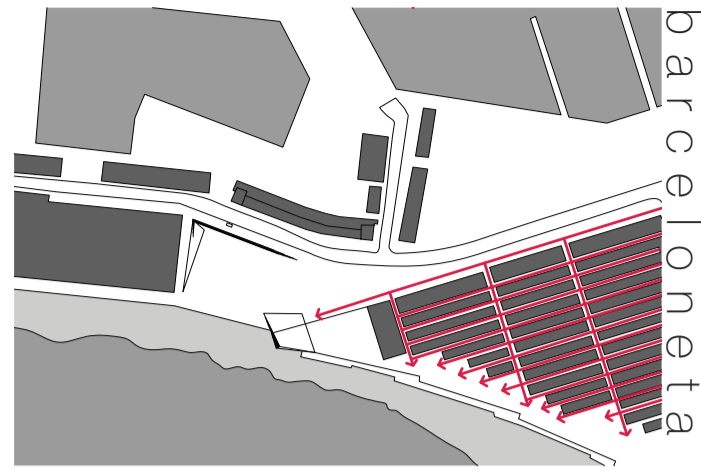

This intervention seeks to facilitate the natural and preexisting conditions of potential market activity on the existing site of Placa del Mar. Using these preexisting conditions and habits, we designed an infrastructure to support these activities based on certain research and design goals. The concept is to give the community of Barceloneta, and the rest of Barcelona, a market that is not an icon nor building, rather an infrastructure for all types of market activity.



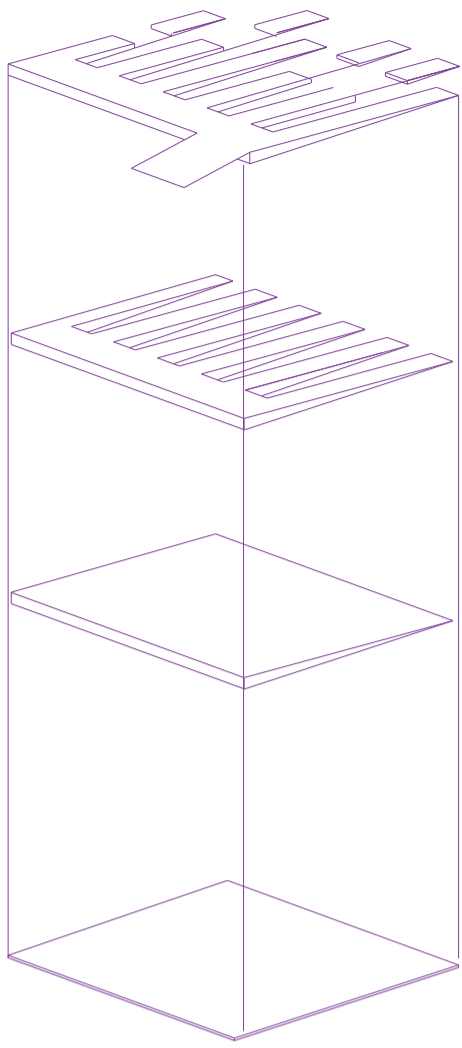

evolution of form

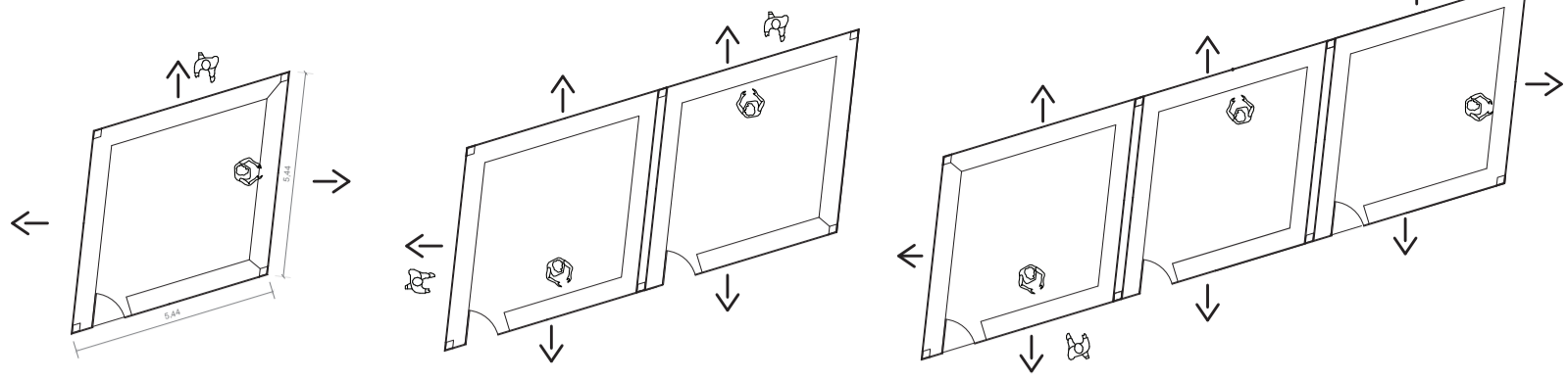

combination of permanent markets

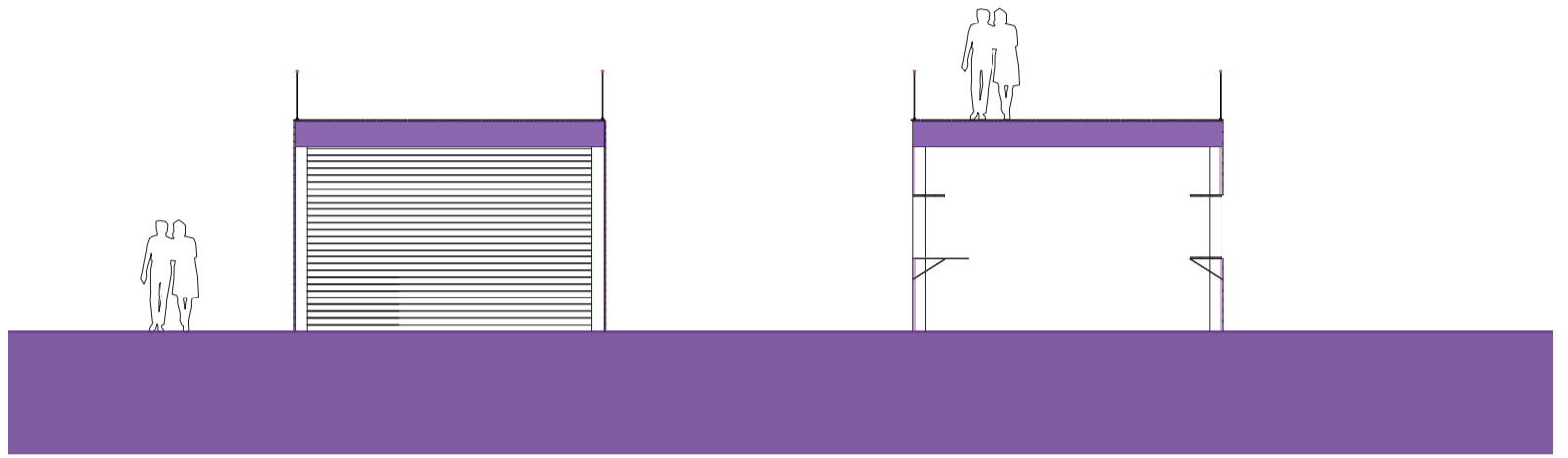

section of market stalls

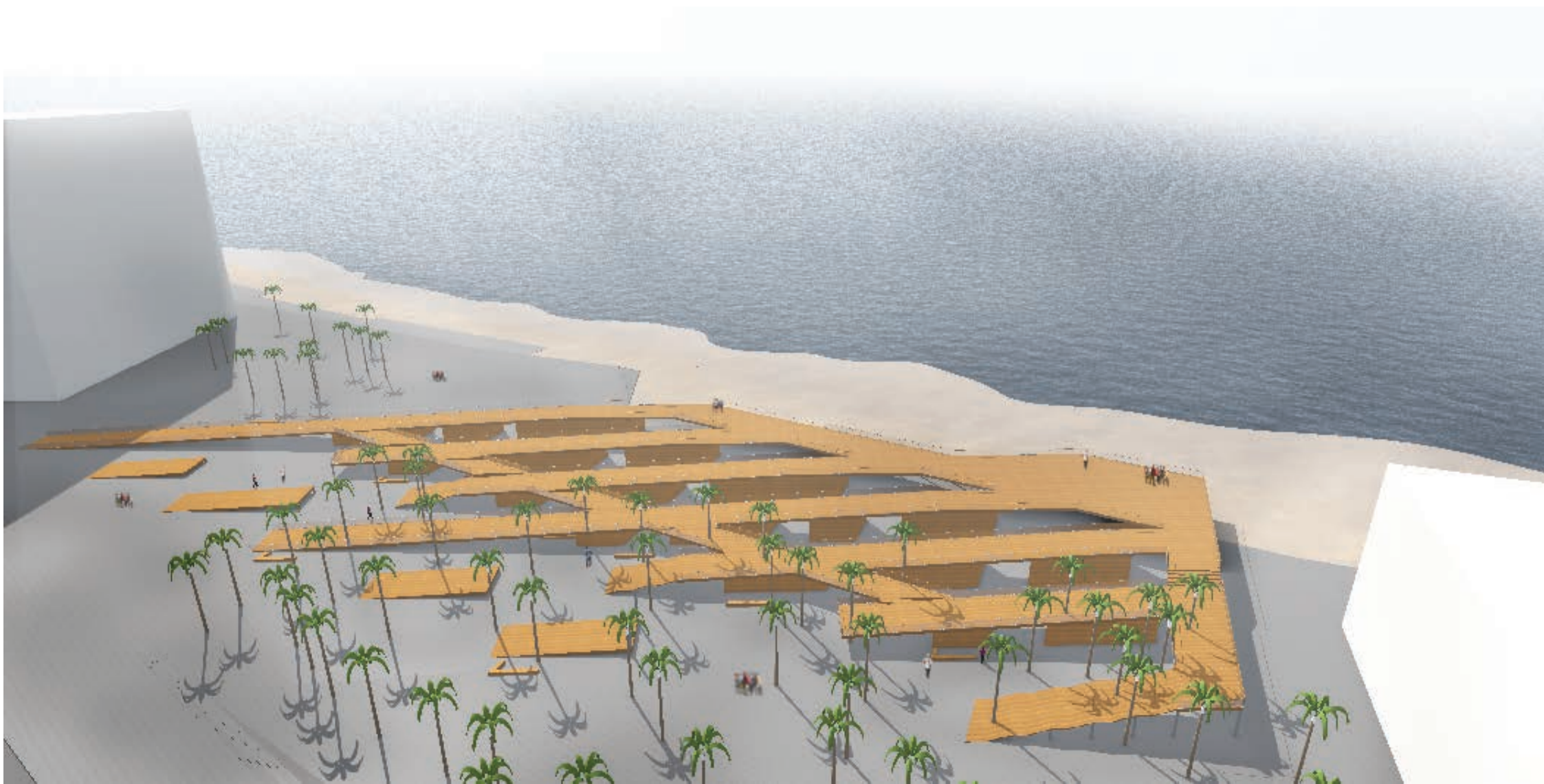
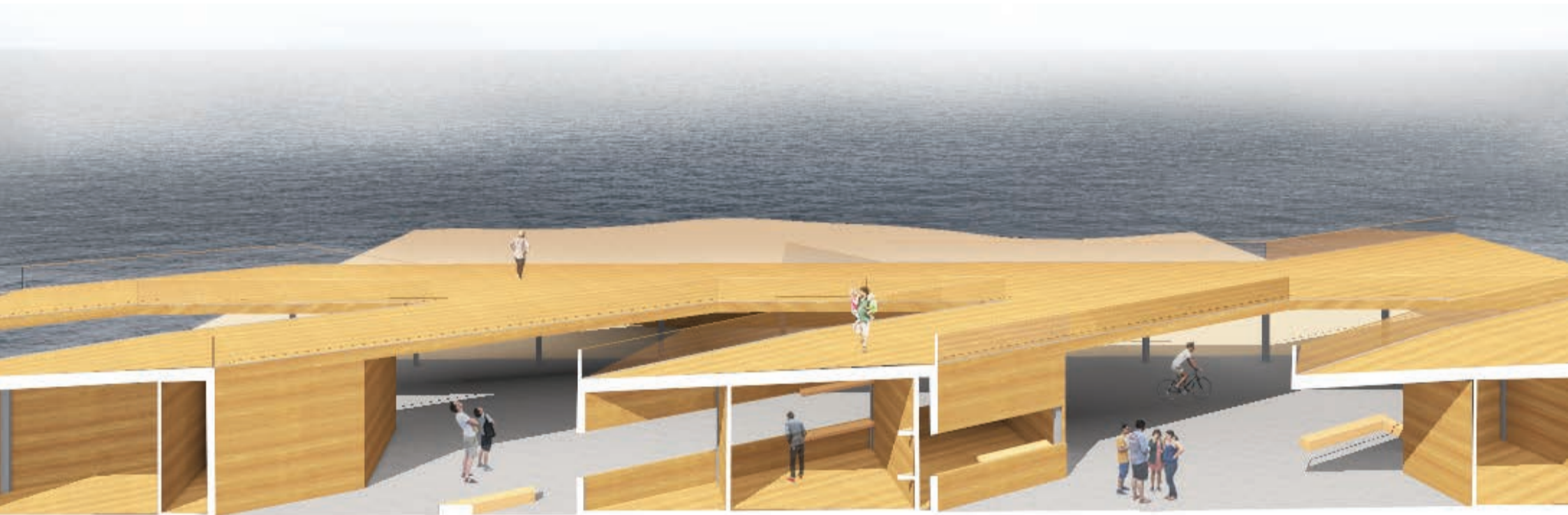

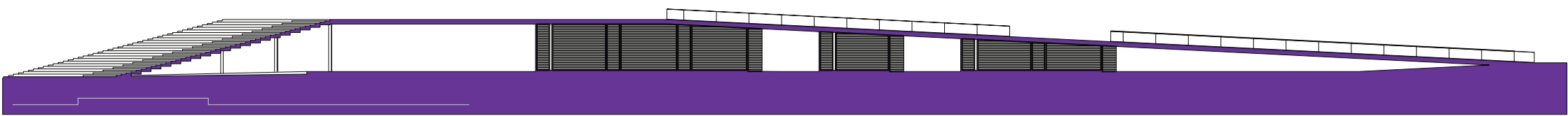

section a - a

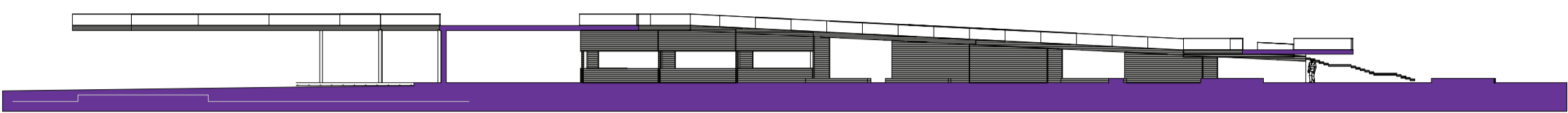

section b - b

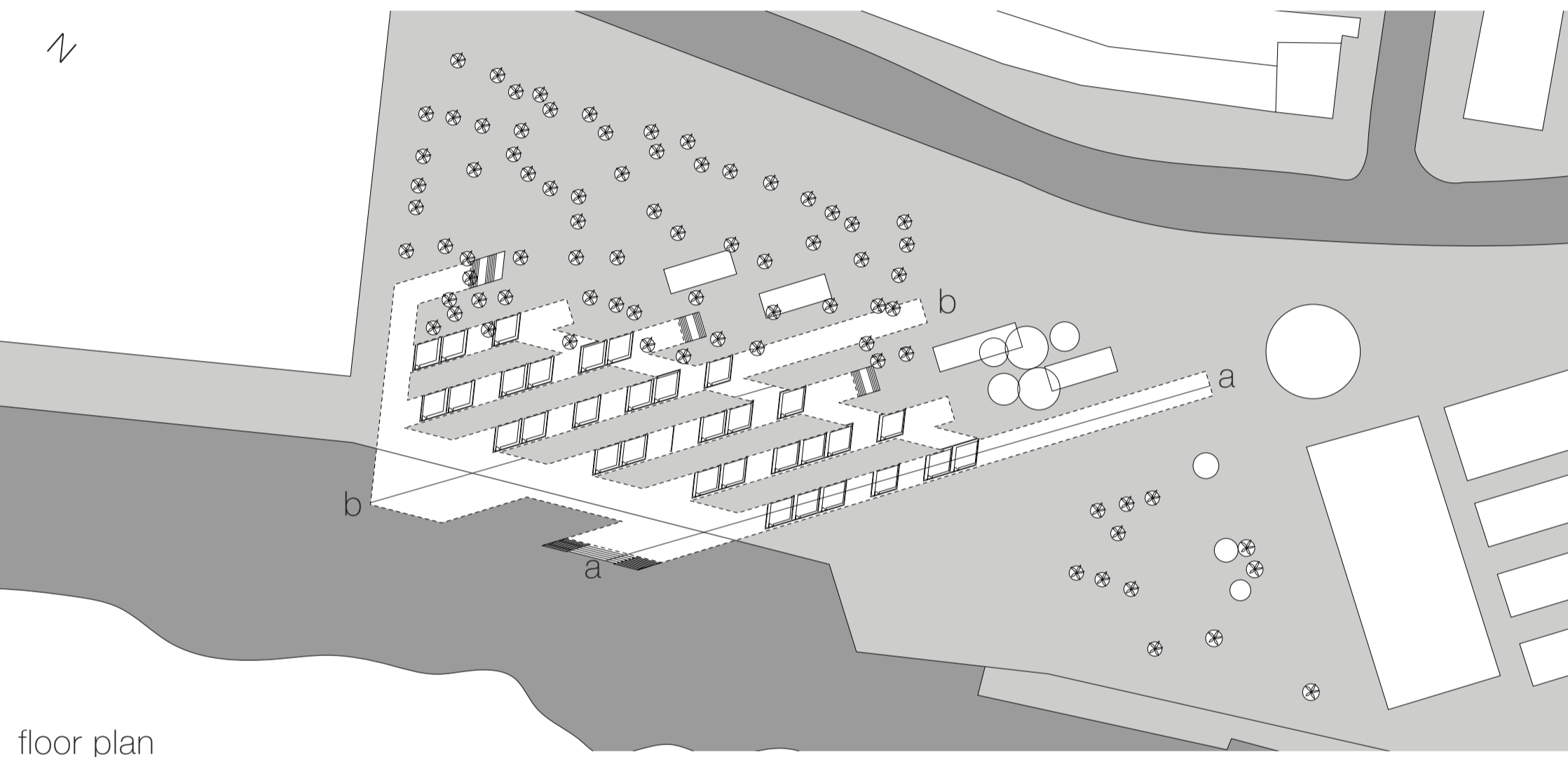

floor plan

